

High-Precision Automatic Inspection and Test Unit for Electrical Resistance Testing RESISTOMAT®

Model 2304

Code: 2304 EN
 Delivery: ex stock
 Warranty: 24 months

2304 EN



Automatic inspection and test unit



Automatic choice of measuring ranges from 200 $\mu\Omega$ to 20 k Ω
 Resolution up to 1 n Ω
 Standard interfaces IEEE488, RS232, RS485, (USB and Ethernet option)
 Checking of tolerances, classification with statistics.

Highest measuring accuracy



Measuring error $\leq 0.01\%$
 Future-orientated measuring method with thermal e.m.f. compensation. High level of stability due to constant comparisons with internal reference values.

Inductive probes



Current regulation results in voltage-free disconnection, calculation of cooling curves of coils.

Menu control



Setting for measuring current entry for absolute or relative limits, classification with statistics, bar display for calibration of measuring probes, determination of resistivity, and many other functions.

Functional Description

The operation of the measuring section of the RESISTOMAT® model 2304 high-precision inspection and test unit is based on an upgraded 4-wire design. It measures not only the voltage drops with injected current across the test object but also across an internal reference resistor. The quotient is calculated from both voltage drops. The resistance of the test object is calculated by multiplying this with the characteristic value of the reference resistor. Apart from eliminating the error of contact layer and contact resistance, this method has the advantage that errors reduce solely to the quality of the internal reference resistors. The deviations in these reference resistances are well known and accounted for the multiplication. The result is that the resistance of the test object can be determined very quickly and accurately irrespectively of the resistances present in the current circuit.

In order to meet high standards in measuring and testing requirements the device was equipped with an integrated high-resolution A/D converter with particularly low linearity deviations. The test objects are measured at both poles, thus eliminating parasitic thermal e.m.f. voltages. The quotient measuring method used, with constant comparison function automatically ensures zero point calibration. Thus an optimum measuring accuracy is guaranteed.

The unit features an extensive standard software for storing measured cooling curve values, temperature compensation, classification, statistical functions, printer and interface drivers, clock, line frequency adaption and so on. Two microprocessors ensure optimum and exact measuring and testing.

For PC user the device software 2304-P001 as well as a Lab Windows driver are available.

Block Diagram

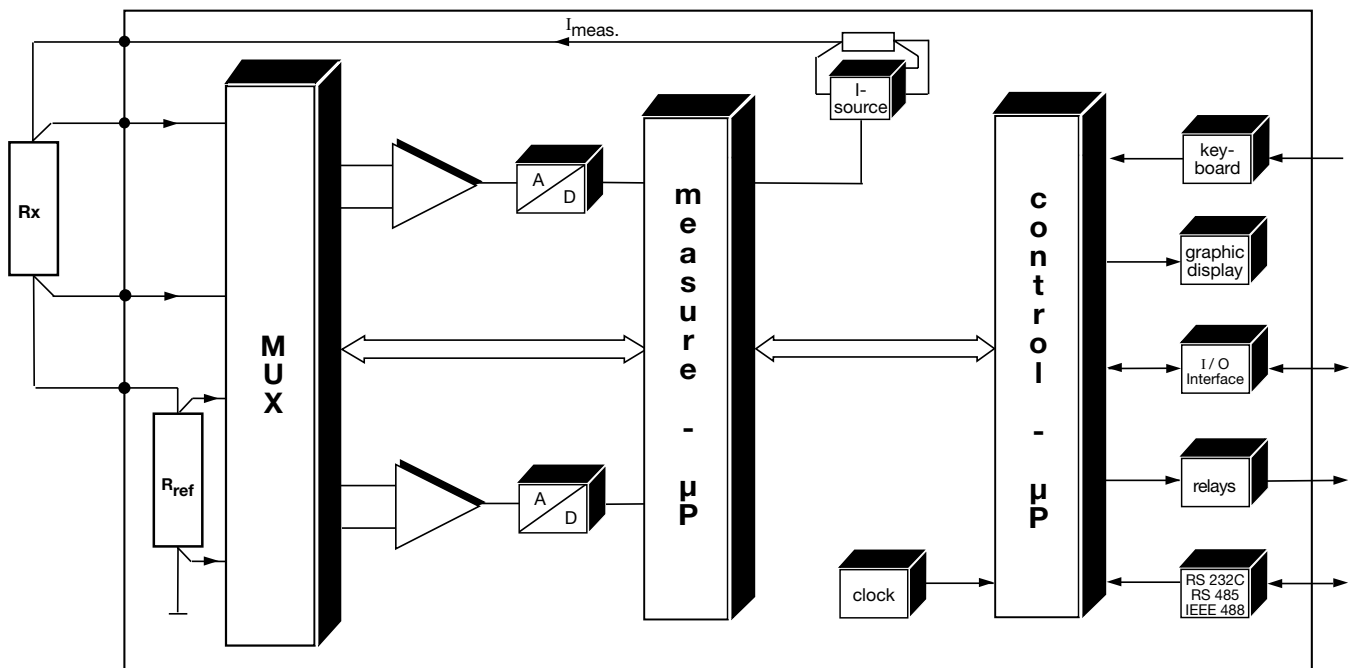

Applications

The automatic inspection and test unit combines a high degree of measuring accuracy, variable resolution and long-term stability with versatile, user-friendly operation. A number of permanently installed programs allow the user to display and evaluate measured values easily. The unit can therefore be used for a wide range of applications:

High-precision measuring of ohmic resistances in the laboratory, test field and production.

Series tests - programmable frequency distribution with switch output per class (histogram), specification of tolerance in absolute or relative values.

Calibration in production - particularly easy, due to the analog bar display for limit values.

Measurements on **coil, motor and transformer windings** - special limiting of the measuring current before disconnecting the measuring lines.

Recording of cooling curves on windings - adjustable time intervals, measured values stored in memories.

Meter probes on cables and wires with temperature compensation and output of measured values in Ω or Δ %.

Determining **resistivity values** with material-related temperature compensation and measurement value output in Ω , Ω/m , Ω/km , $\Omega/10$ ft and Ω/kft .

Measurements of **contact resistances** on switches, relays, push button contacts with low measuring current, volume resistance on fuses.

Technical Data

Design

The device is designed in a modular system and embedded in a stable housing of sheet steel. Therefore every structural component is easily accessible and thus an optimal service is secured.

All operational control elements, the LCD graphic display and the connector box are situated clearly and easy to survey on the front panel. On the rear panel the in- and outputs of the interfaces are placed as well as of the comparators and the Pt100 sensor for temperature compensation and for controlling the instrument.

Measuring Data

Resistance measuring range	Resolution	Measuring current
200.000 $\mu\Omega$	0.001 $\mu\Omega$	10 A
2.00000 m Ω	0.01 $\mu\Omega$	10 A, 1 A
20.0000 m Ω	0.1 $\mu\Omega$	10 A, 1 A, 100 mA
200.000 m Ω	1 $\mu\Omega$	1 A, 100 mA, 10 mA
2.00000 Ω	10 $\mu\Omega$	1 A, 100 mA, 10 mA, 1 mA
20.0000 Ω	0.1 m Ω	100 mA, 10 mA, 1 mA, 100 μ A
200.000 Ω	1 m Ω	10 mA, 1 mA, 100 μ A
2.00000 k Ω	10 m Ω	1 mA, 100 μ A
20.0000 k Ω	0.1 Ω	100 μ A

Measuring method:

Quotient method with Kelvin-4-terminal measurement

Error of measurement (switched off temp. comp.):
down to ± 0.01 % of reading, ± 2 counts, depending on range

Max. input voltage (no load operation) $\leq \pm 16$ V

Measuring connection:

4-terminal principle for current-voltage measurement (Kelvin), potentialfree circuit design, potential binding either at the test object or at the RESISTOMAT®.

Max. load voltage: 10 V at $I_{\text{meas.}} = 100 \mu\text{A}$ to 1 A
6 V at $I_{\text{meas.}} = 10$ A

Max. over-voltage on measuring input: 100 V DC

Measuring time:

adjustable, calculation of mean value (up to 255 values) possible

Display	measuring time with pure ohmic sample
3 1/2 digit	≤ 300 ms
4 1/2 digit	≤ 500 ms
5 1/2 digit	≤ 5 s

Measuring method: continuous, single, unipolar or bipolar

Range selection: manually, automatically or via interface

Zero balance: μP -controlled

General Data

Display:

240 x 64 dots transfective LCD graphic display with adjustable contrast and background lighting.

Overload indication:

>>>

Outline of measuring value:

alternatively 3 1/2, 4 1/2, or 5 1/2 digit, LCD 15 mm height, reading absolute or in Δ %.

Power supply:

230 V + 6 % - 10 %;
115 V as option

Power frequency:

45 - 65 Hz

Power requirement:

max. 260 VA

Environmental conditions:

operating temperature range +5 ... **23** ... 40 °C,
max. 90 % rel. humidity, not condensing
storage temperature range 0 ... **23** ... 60 °C

Potential binding:

measuring part internally grounded, reversible to external grounding

Watch:

buffered by internal battery

Parameter input:

by entry keys or interfaces

Weight:

28 kg

Dimensions (width by height by depth): 520 x 255 x 480 [mm]

Safety:

EN 61010

Connections

Probe connections:

Front panel: via 4 safety bushers, 4 mm \varnothing , immersed.
Rear panel: 5 pin LEMO-bush EGG. 2B. 305

Over a 37 pin submin D-bush on the rear panel it is possible to pass-through the following signals:

Optocoupler output:	"operate"
	"trouble"
	"stop/go"

Optocoupler input:

9 change-over contacts for sorting:	
max. voltage	42 V
max. current	0.5 A

Pt 100 sensor for temperature compensation:

6-pin LEMO-bush EGG. 1B. 306

Interface Connections

IEEE488 interface:

24-pin plug type standard connector open collector output SH1, AH1, T6, TE \varnothing , L4, LE \varnothing , SR1, RL1, PP \varnothing , DC1, DT1, C \varnothing instruction language SCPI, version 1990.0

RS232C interface:

full duplex	with RTS, CTS
25-pin	submin D-bush
baud rate	600 - 9600
protocol	ANSI X 3.28 subcategory 2.5, A3/A4
instruction language	SCPI, version 1990.0

RS485 interface:

full duplex/half duplex	without internal closing resistors
25-pin	submin D-bush
protocol	ANSI X 3.28 subcategory 2.5, A3/A4
instruction language	SCPI, version 1990.0

Printer:

Connection to RS232 interface

Overview Adjustments and Configurations

The many application orientated adjustments of the inspection and test unit are accompanied by a compact operator guidance. The following diagram provides an overview for the existing menus and measuring programs.

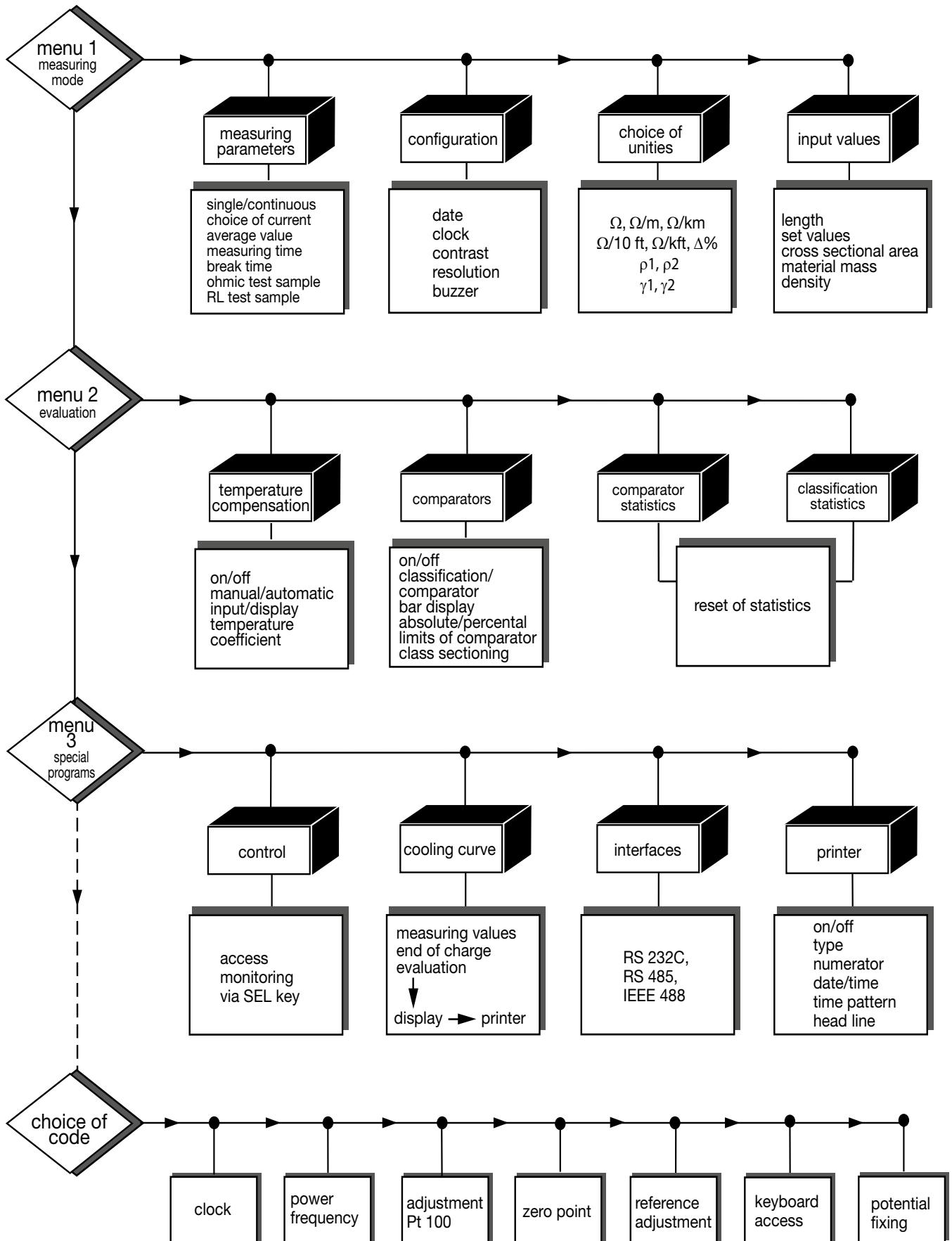

The solution for your day by day measuring problems: the RESISTOMAT® 2304

Display of measured values, adapted to your working conditions:

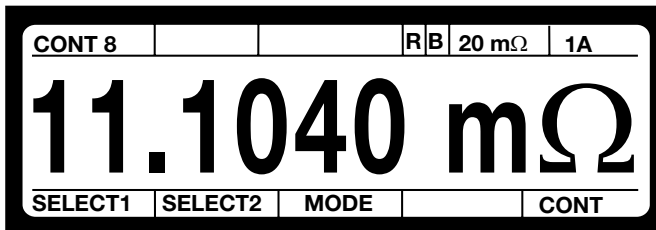

Example: main menu 1 with 5 1/2 reading of absolute value, additionally display of the measurement unit

In absolute values, digital, 3 1/2- up to 5 1/2 digit, that means resolution, adapts to the application requirements i.e. 1.234 Ω or 1.23432 Ω;

in relative values as percental difference to a given set value. Display i.e.: -1.23 %

as quasi analog bar. You immediately realize where the instantaneous value ranges within in the tolerance field.

Independent from the display you can choose as unit Ω, Ω/m, Ω/km, ρ (specific resistance) or κ (specific conductance). In the sub menu of the unit choice the RESISTOMAT® requires the data for calculating the specific values, as i.e. length, cross section, mass, density, and so on.

On **resistance testing of windings** on transformers, motors, coils a.s.o. with inductive parts the RESISTOMAT® helps with

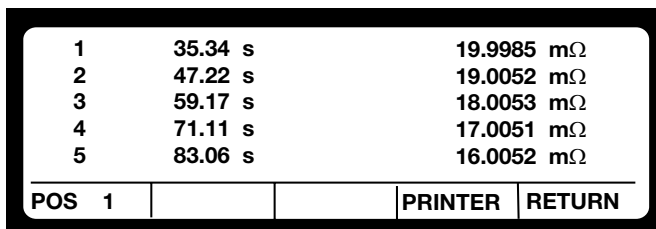

1	35.34 s	19.9985 mΩ
2	47.22 s	19.0052 mΩ
3	59.17 s	18.0053 mΩ
4	71.11 s	17.0051 mΩ
5	83.06 s	16.0052 mΩ
POS 1		PRINTER RETURN

Example: presentation of automatically stored values with indication of recording time

short measuring times due to single polarity measurement;

determination of cooling-down curves: the device stores up to 256 measuring points. Start-up time, end of recording and time division are at your free disposal; output of measuring values directly to the printer;

voltage-free disconnection of test samples: a special circuit regulates the measuring current down to zero. The end of the regulation is pointed out by a LED.

On **cable standing and wire twisting** the RESISTOMAT® saves raw material and money:

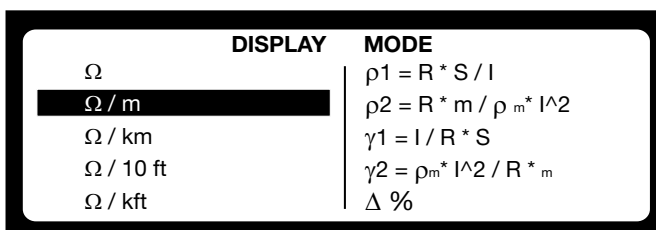

DISPLAY	MODE
Ω	$\rho_1 = R \cdot S / l$
Ω / m	$\rho_2 = R \cdot m / \rho_m \cdot l^2$
Ω / km	$\gamma_1 = l / R \cdot S$
Ω / 10 ft	$\gamma_2 = \rho_m \cdot l^2 / R \cdot m$
Ω / kft	Δ %

Example: choice of unit on display menu

Along with wire holding devices models 2381/82 - or as stand-alone device - RESISTOMAT® model 2304 measures resistances or specific resistances and specific conductivities on cable probes - just like the user is accustomed and always with the same accuracy and the same resolution. You can work with or without temperature compensation. The temperature of the test sample is either measured with a sensor or put-in manually. You can store the temperature coefficient of max. 10 materials and choose one for working. Or you adjust the individual value of "your probe".

For **quality control** the RESISTOMAT® offers following easements:

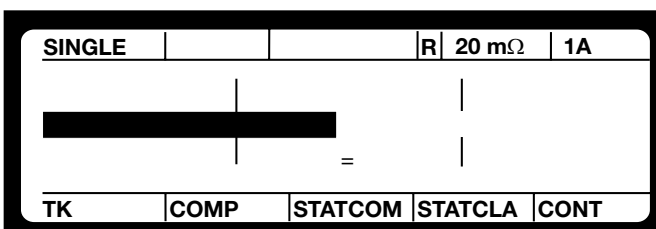

Example: bar indication with flashing-in of limits and comparator results

Bar or percentage indication: for adjustment processes

Perfect integration in test systems by control possibilities via all common interfaces.

2 limits with switch outputs select the probe in the ranges "too small", "good", "too high".

Statistic and classification function: counts and divides the sample in max. 8 classes.

Is there a new test sample on line? The RESISTOMAT® is quickly reconfigured via one of the interfaces or manually by the keyboard.

Application Example

Recording of cooling curve on motors or transformers

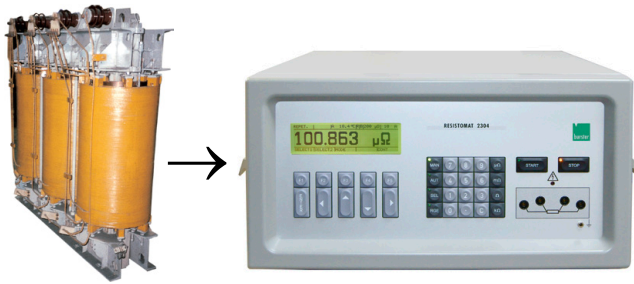

Rc:	4.387	Ω		
T1:	+ 23.0	°C		
Δ t:	1	s		
R(t):	5.264	Ω		
T2:	+ 28.0	°C		
	+/-	L-REM	MEAS-t	EVAL

Cooling curve parameters and display

Transformer

In a freely selectable time interval up to 255 measurement values can be stored.

After completion of the measurement the values are displayed in tabular form respectively can be transmitted to a PC.

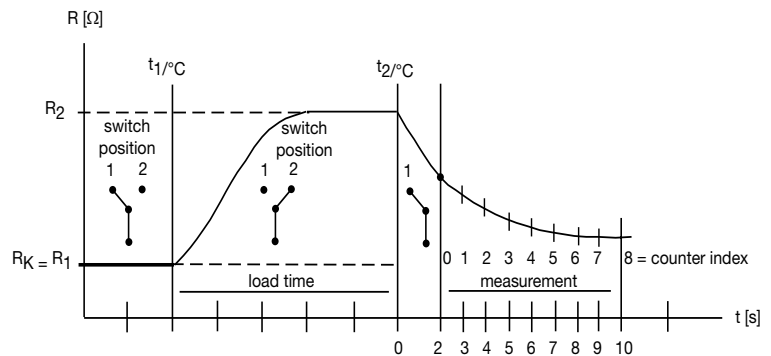
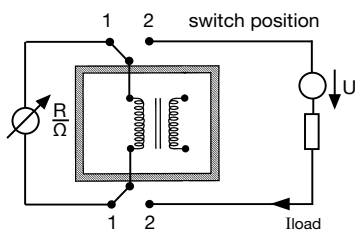

Change of resistance of a transformer winding in relation to the time factor.

Order Information

RESISTOMAT®

Model 2304

Accessories

Temperature sensor with 2.5 m cable and connector

Model 2392-V001

37-pin connector suitable to optocoupler in- and outputs and relay contacts

Model 9900-V165

25-pin connector suitable to RS232C (interface)

Model 9900-V160

RS232 data transmission lead

Model 9900-K336

USB Converter

Model 9900-K351

Ethernet Converter

Model 9900-K453

5-pin connector for connecting the test probe on the rear panel

Model 2304-Z003

19"-rack mounting kit

Model 2304-Z004

DKD/DAkKS Calibration Certificate Model 23DKD-2304
WKS Calibration Certificate Model 23WKS-2304

Device and documentation software incl. data transmission lead model 9900-K336 **Model 2304-P001**

With this program measuring values from 2304 can be stored in an ASCII data file and can be reprocessed in Excel. In addition value and unit, time and date are stored. Upon start of the measurement a text with 80 characters can be entered which is written into the first line of the file.

Operating system: WIN ME, WIN2000, WIN NT4.0, WIN XP, VISTA

Device Calibration

On a standard calibration certificate the devices are calibrated in each range with one point in the middle range.

For DKD/DAkKS (Deutscher Kalibrierdienst) calibrations we use PTB calibrated standards, for WKS (Werkkalibrierschein) calibrations we use DKD/DAkKS calibrated resistors.

With a calibration set the customer is able to effect an easy, software supported recalibration.

Calibration set (for customer recalibrations)

consists of 5 calibration resistors of series 1240 with DKD/DAkKS Certificate 100 μΩ, 1mΩ, 10 mΩ, 100 mΩ, 1 Ω and one adaptor model 2394 **Model 2304-Z010**

Kelvin measuring tongs and probes see data sheet 2385 EN

Wire holding device for wires up to 2500 mm² see data sheet 2381 EN

Calibration resistors see data sheet 1240 EN