

THE MEASUREMENT SOLUTION.

**burster**



DIGIFORCE® —  
because every hit counts.

**PRECISION MEETS SPEED.**



# DIGIFORCE®

PIONEERING PROCESS CONTROL – MADE BY burster.

## SECURITY FOR YOUR PRODUCTION

DIGIFORCE® **monitors processes** in which precisely defined functional relationships between two or more process-relevant quantities need to be demonstrated. Recording, visualizing and evaluating the **X/Y curve** allow 100% monitoring of process quality, ensuring that the production step and every single produced part are checked.

DIGIFORCE® 9307 and DIGIFORCE® 9311 are **pioneering process controllers** developed for the demands of a challenging, often automated production. Both models are exemplary in their class, delivering rapid, precise evaluation results for applications that demand both high quality and high productivity. **Take advantage now of greater security** in your production process.



## EXPERTS IN EVERY FIELD

**DIGIFORCE® controllers are incredibly versatile.**

They enjoy the trust of countless users in industries with extremely high quality standards; industries such as mechanical and plant engineering, automation and the automotive sector and its suppliers. And in increasingly important markets such as medical technology, biotechnology, e-mobility and drive engineering, DIGIFORCE® systems are already making a vital contribution to quality assurance.

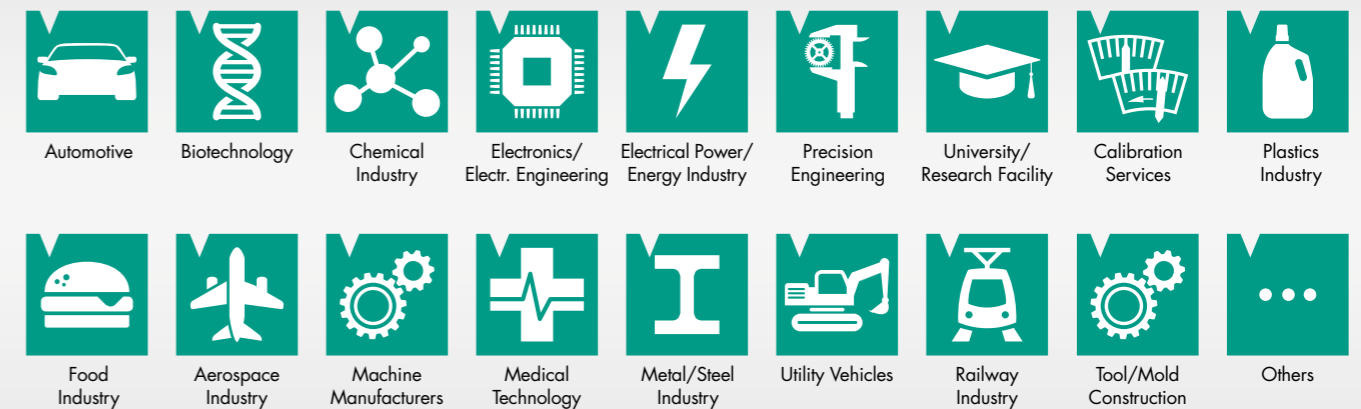

## KEEPING INNOVATION IN THE FAMILY

**DIGIFORCE® is the process monitoring system that keeps raising the bar.**

The instruments in the DIGIFORCE® family are the benchmark of reliability when it comes to comprehensive monitoring of press-fit, joining, riveting and caulking processes, torque measurement or universal signal testing. Whatever the movement or joining system – pneumatic, hydraulic or servo-electric – DIGIFORCE® controllers are versatile to integrate with all forms of motion technology.

**Cut your quality costs** – DIGIFORCE® provides a detailed process analysis for continuous optimization. With DIGIFORCE® you are already equipped today for the growing demands of tomorrow's customers and markets.

### Multitalent.

Unsurpassed performance scope in its class.

### Pace-setter.

Extremely rapid measurement and quick evaluation.

### Allrounder.

Support all relevant fieldbus interfaces.

### Precision pro.

Highly accurate measurement results.

### Quick-starter.

Automated sensor recognition and setup of evaluation elements.

### Mathematical wizard.

Process security at a fair price.

## INTEGRATES INTO ANY SYSTEM

**Industry 4.0**, the term coined for the smart factory revolution, depends on the increasing interconnection of people, machinery and product. A system-safeguard requirement placed on all those involved in a process is to design the basic production processes to be analyzable, controllable and safe.

**DIGIFORCE® 9307 and DIGIFORCE® 9311 can be integrated into practically all controller or host environments.**

The smart process monitoring systems visualize, analyze and evaluate important customizable parameters, and can transmit these parameters via the latest communication interfaces. Process status messages are routed to higher-level controllers in real time via Ethernet-based fieldbuses.

### Communications interfaces:

- USB front-panel
- RS232\*
- Ethernet

### Fieldbus interfaces:

- I/O interface
- PROFIBUS
- PROFINET
- EtherNet/IP
- EtherCat\*

\* DIGIFORCE® 9307 only



# DIGIFORCE® 9307

INTELLIGENT HIGH-END TECHNOLOGY.

## A CLASS OF ITS OWN FOR ACCURACY

**DIGIFORCE® 9307, the next generation of universal process controllers, is based on the entire applications experience of our customers, which has been applied to set new standards in the high-end sector of complex process monitoring.**

Outstanding accuracy is a particular strength of the system; with an accuracy of 0.05 % of full scale for strain gauge sensors and analog process signals, your quality control system is on the safe side. The system also offers short response times, a wide choice of sensors and versatile fieldbus interfaces to provide a first-class solution even for complex monitoring tasks.

- Maximum precision for toughest requirements
- Simultaneous monitoring of two synchronous processes
- 128 measurement programs for a large variety of parts
- High measurement accuracy: 0.05% of full scale at 10 kHz sampling rate
- Smart signal sampling using a combination of  $\Delta t$ ,  $\Delta X$ ,  $\Delta Y$
- Ultra-fast evaluation (15 ms) and data transfer of dynamic measurements
- Fieldbus data logging in real time
- USB service interface on front-panel

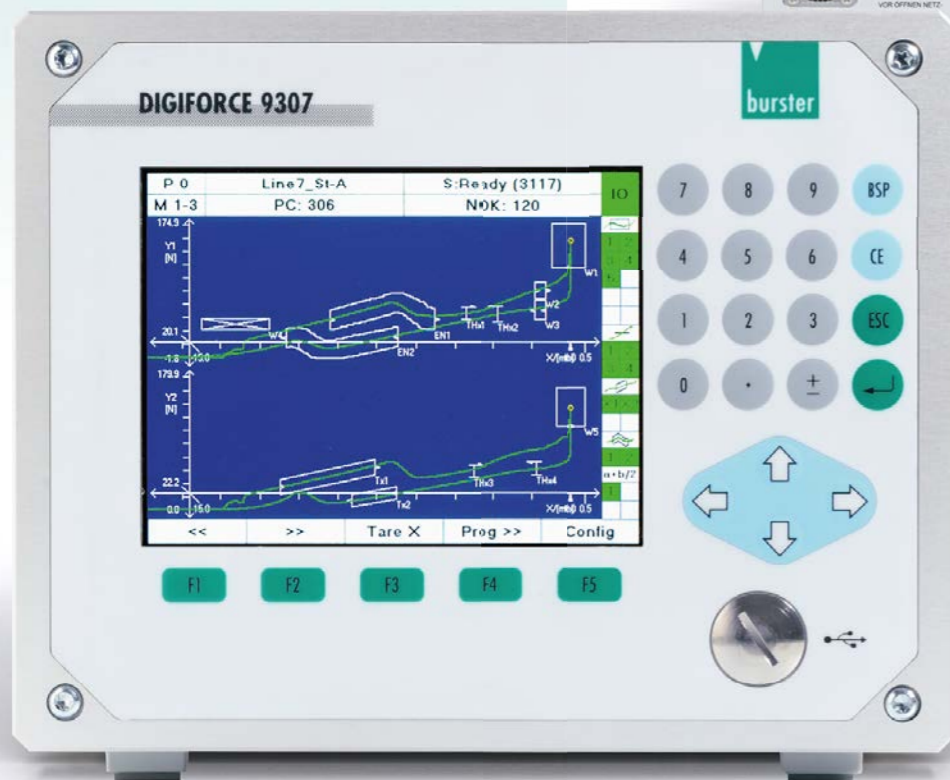

Further information:  
[www.digiforce.info](http://www.digiforce.info)

## EVALUATION THAT GIVES YOU EXTRA

**DIGIFORCE® 9307 supports numerous measurement procedures and evaluation techniques.** Even **complex X/Y curves** can be analyzed thanks to a range of evaluation elements such as windows, thresholds, trapezoids, envelopes and extra mathematical operations. In addition to the global **OK/NOK result**, the user also gets detailed process information for a differentiated view and evaluation.



Window with configurable entry/exit sides, online signal, entry/exit coordinates, absolute and local min/max values, mean value, inflection point, gradient, area



Envelope curve, configurable entry/exit sides



Trapezoid window type X or Y, configurable entry/exit sides

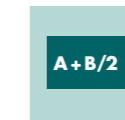

Basic mathematical operators for calculating individual process values including evaluation (min/max comparison)



Threshold type X or Y, configurable crossing, crossing coordinates, absolute and local min/max values, mean value, inflection point, gradient, area

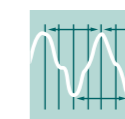

Rotary-switch evaluation for monitoring cyclical switching between maxima/minima

## INTEGRATION WITH EASE

A wide choice of **fieldbus interfaces** and **Ethernet-based fieldbus protocols** ensures quick and reliable integration of DIGIFORCE® 9307 in practically every process environment.

- I/O interface
- PROFIBUS
- PROFINET
- EtherNet/IP
- EtherCAT

## READY FOR YOUR SENSORS

**DIGIFORCE® 9307 supports all main sensor types.**

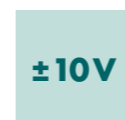

- Strain gauge
- Potentiometer
- Process signal analog
- Piezo
- Incremental
- EnDat
- SSI
- Torque/Angle of rotation
- Resistance





# DIGIFORCE® 9311

THE BENCHMARK OF ECONOMICAL QUALITY CONTROL.

## EVERYTHING RELIABLY UNDER CONTROL

The pioneering **DIGIFORCE® 9311 force/displacement controller** delivers rapid, precise evaluation results for applications that demand both high quality and high productivity. The smart performance features and intelligent hardware **save setup times, simplify operation** and ensure **autonomous integration** in modern production systems. The unrivalled product specification gives businesses more security and dependability they need for increasingly complex production processes.

- Simple, quick setup on color display with touch operation
- 16 measurement programs
- USB service interface on front-panel
- Fieldbus data logging in real time
- Display and analysis of last 50 measurements
- Universal multi-area measurement channels
- Quick USB data logging
- Automatic sensor recognition thanks to burster TEDS

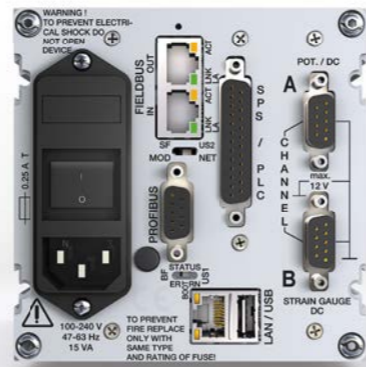

## PRACTICAL EVALUATION TOOLS

**DIGIFORCE® 9311 supports numerous measurement procedures and evaluation techniques.** Evaluation elements such as **windows, thresholds, trapezoids and envelopes** can be used to monitor a full curve, measure process-relevant variables and quickly signal a pass/fail result.



Window with configurable entry/exit sides, online signal, entry/exit coordinates, min/max values



Threshold type X or Y, configurable crossing



Trapezoid window type X or Y, configurable entry/exit sides



Envelope curve, configurable entry/exit sides

## FLEXIBLE INTEGRATION

**DIGIFORCE® 9311 is ready to integrate easily into your process environment,** as it comes with the relevant fieldbus interfaces:

- I/O interface
- PROFIBUS
- PROFINET
- EtherNet/IP

## AUTOMATIC SENSOR RECOGNITION

DIGIFORCE® 9311 includes the **burster TEDS** feature for the efficiency and security you need today. It can automatically read an electronic datasheet stored in the sensor for automated measurement-channel configuration. This efficiently safeguards the system from incorrect parameter settings.



## COMPACT SENSOR PACKAGE

**DIGIFORCE® 9311 supports a choice of major sensors.**

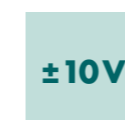

- Strain gauge
- Potentiometer
- Analog process signal
- Piezo



# Quality in Focus

**DIGIFORCE® – RELIABILITY AND CONTROL FOR EVERY JOB.**

## ASSEMBLY/SEATING

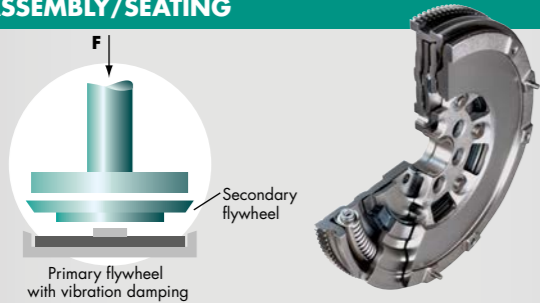

Monitoring primary and secondary flywheels of a dual mass flywheel during assembly.

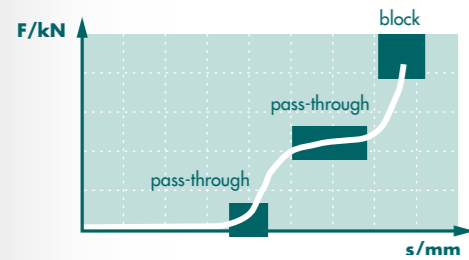

## TORQUE/ANGULAR DISPLACEMENT



Torque/angle monitoring for vehicle controls. The haptic response of rotary switches is analyzed from the torque/angle curve.

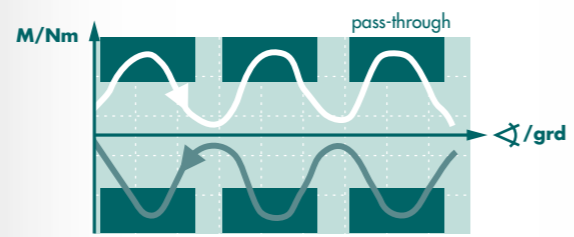

## CRIMPING

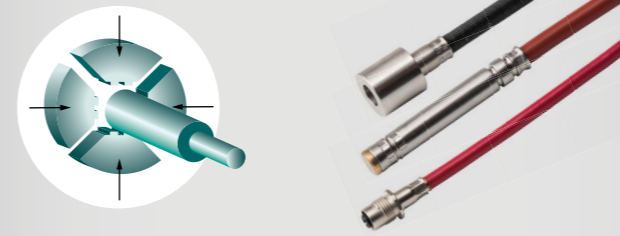

To monitor crimping processes, the force applied by the jaw segments to the material deformation is analyzed as a force/time curve. Wear to a jaw segment or breakage can be detected.

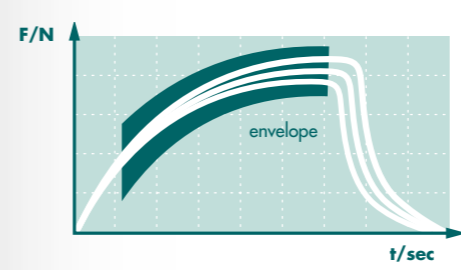

## RIVETING



Monitoring the setting process when riveting ABS components. The oil pressure and oil volume flow rate are measured and analyzed at the hydraulic setting tool.

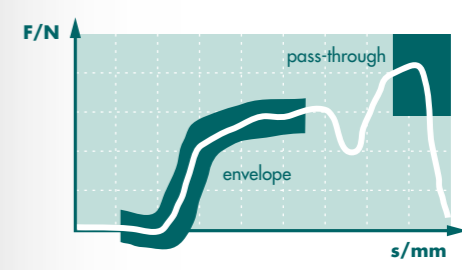

## HINGE TESTING

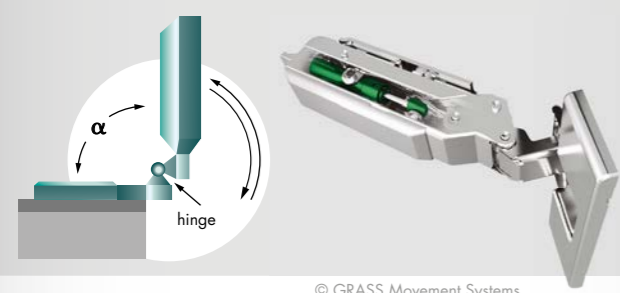

Measuring the correct torque/angle response in final testing of hinges.

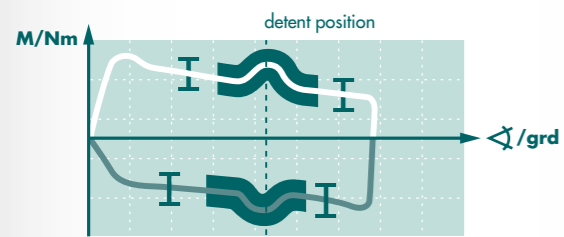

## JOINING AXES

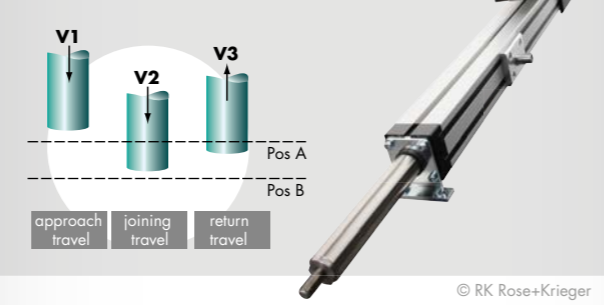

When monitoring the joining process on servo-electric joining axes, the relevant process variables can be measured either directly at the front end of the joining axis or indirectly, e.g. from the motor rotation.

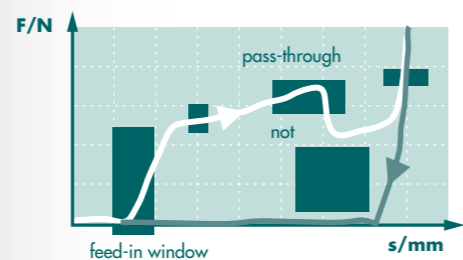

## MANUAL PRESSES

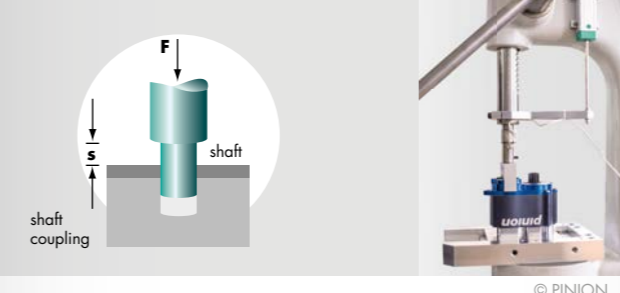

100 % monitoring at a manual workstation for gear assembly.

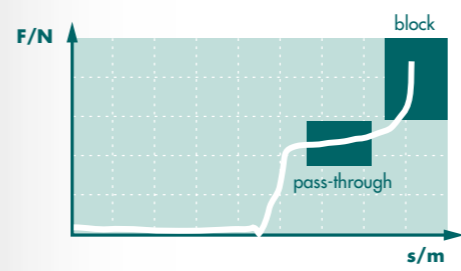

## JOINING

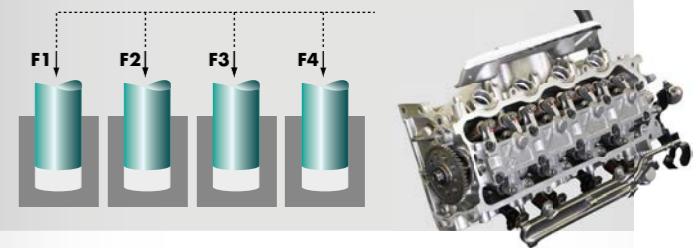

Multichannel monitoring of joining process in cylinder head assembly. The synchronous process during the assembly of valve seating rings and valve guides is measured and analyzed. DigiControl PC software logs and visualizes the process data from up to 32 controllers.

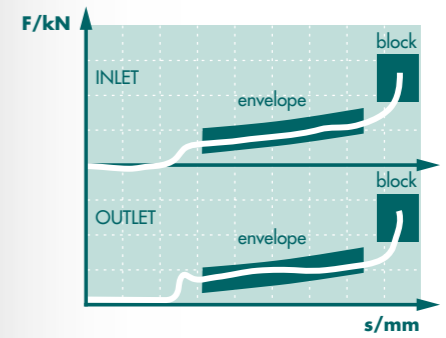



# Quality in Focus

DIGIFORCE® – RELIABILITY AND CONTROL FOR EVERY JOB.

## TESTING SPRINGS

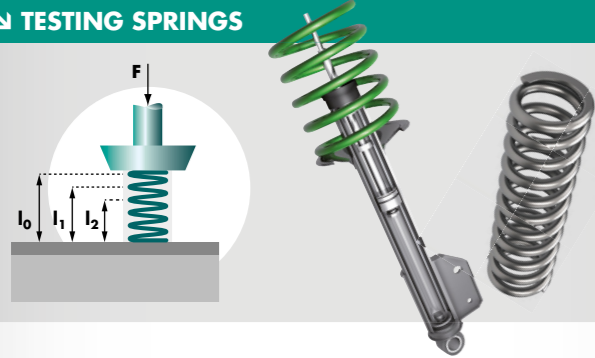

Testing of spring constant and hysteresis between applying and removing load.

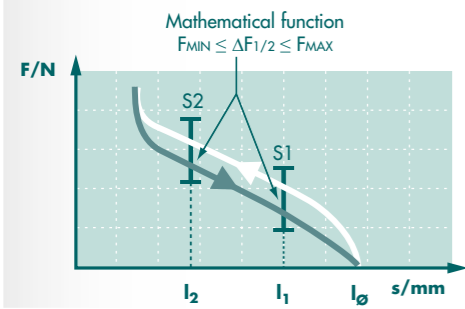

## CLINCHING

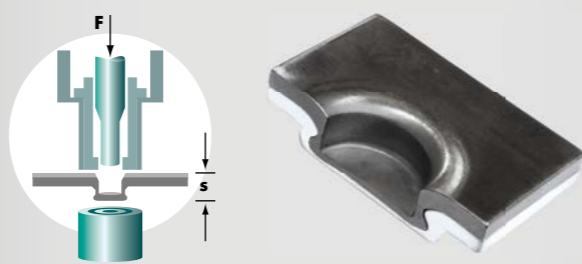

The flow process produced in the two sheet metal parts by the clinching stamp and die is monitored by a force/displacement measurement.

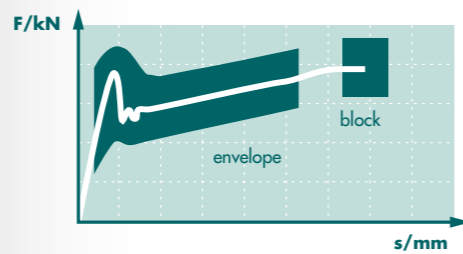

## PRESS-FITTING



Monitoring the press-insertion of ball bearings in bearing cups.

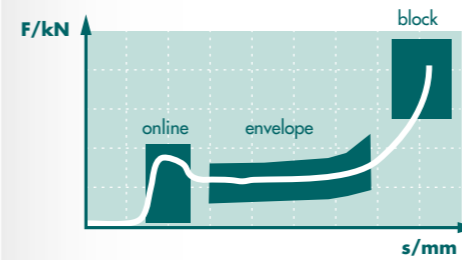

## FORCE/DISPLACEMENT CURVE

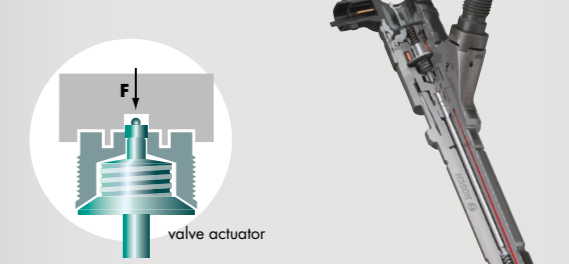

Press-insertion and precise positioning of the valve actuating elements are monitored during assembly of common-rail injectors.

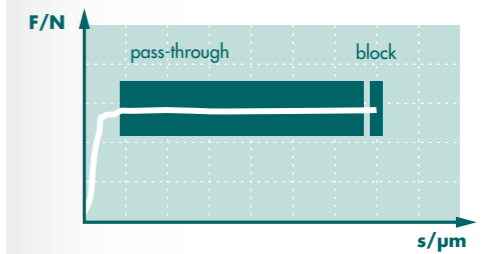

## FRICION TESTING

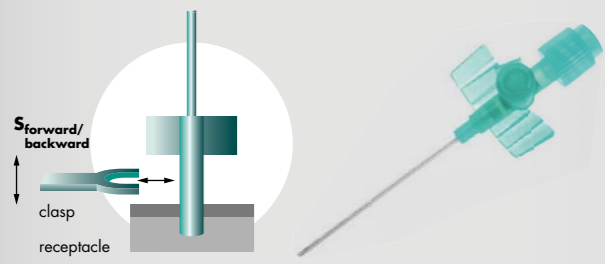

Testing the ease of movement of a venous canula over the length of the steel insertion needle. The clasp holds the canula and moves it up and back over the needle.

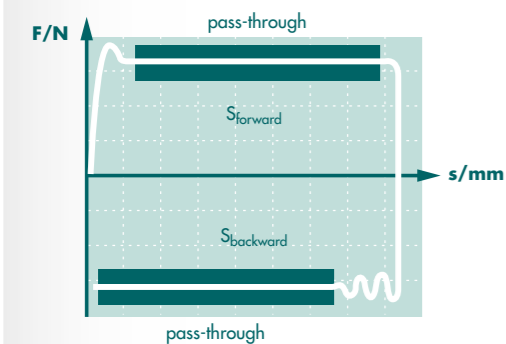

## DYNAMIC DAMPING RESPONSE

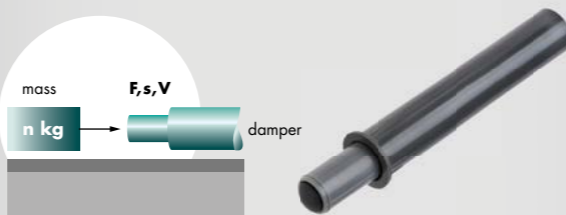

When monitoring e.g. furniture dampers, force and displacement over a defined period are measured in order to test and evaluate the damping response during the approach of an accelerated mass.

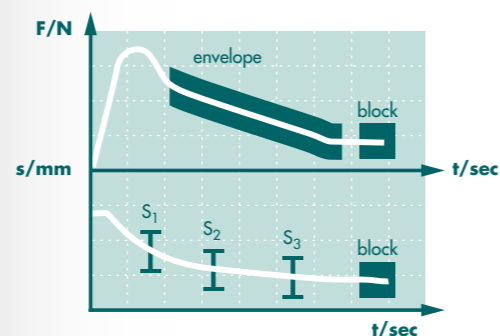

## TORQUE

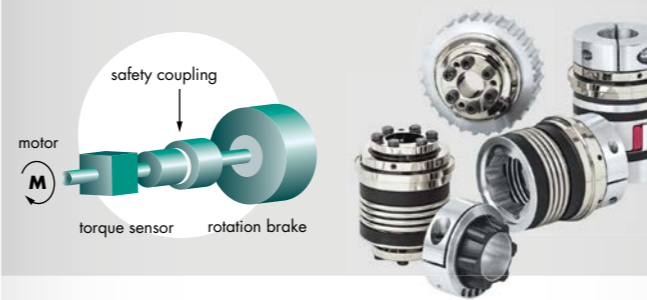

Testing the moment of release of a torque safety coupling under dynamic load.

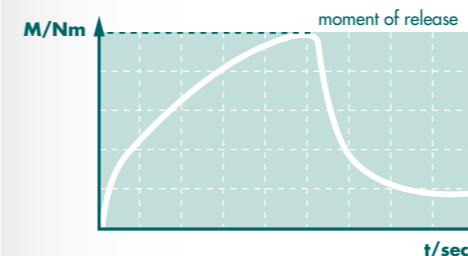

## SIGNAL TESTING/LEAKS

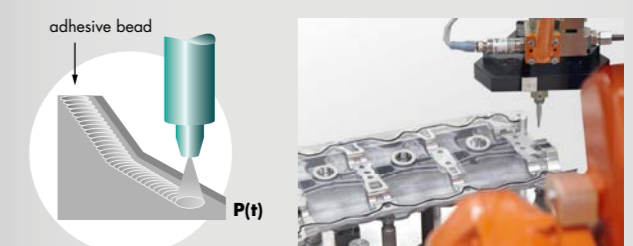

Checking for continuous application of adhesive beads, e.g. to prevent leaks from gaps in the adhesive joint. This is done by monitoring the pressure/time curve in the dispensing line.

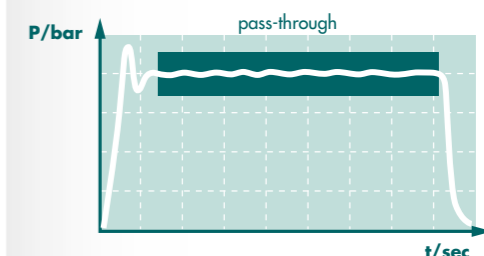





# DIGIFORCE® 9307/9311

THIS COMPARISON STANDS UP TO EVERY CHALLENGE.

# DigiControl

IT COULD NOT BE EASIER.

	DIGIFORCE® 9307	DIGIFORCE® 9311
		
<b>Area of use</b>	Universal Process Controller for monitoring press-fit and joining operations, torque and process curves, spring and switch testing including resistance measurement, signal testing and leak detection.	Force/displacement Controller for processes in which precisely defined functional relationships between two process-relevant quantities need to be demonstrated.
<b>Measurement channels</b>	6	2
<b>Active channels</b>	3	2
<b>Type of sensor</b>		
Strain gauge	■	■
Potentiometer	■	■
Process signal analog	■	■
Incremental	■	
SSI	■	
EnDat	■	
Torque	■	
Angle of rotation	■	
Piezo	■	■
<b>Measurement accuracy</b>	0.05 % F.S.	< 0.2 % F.S.
<b>Fieldbus interfaces</b>		
I/O interface	■	■
PROFIBUS	■	■
PROFINET	■	■
EtherNet/IP	■	■
EtherCAT	■	
<b>Interfaces</b>		
USB (front-panel service port)	■	■
USB master		■
RS232	■	
Ethernet	■	■
<b>Max. amount of measurement channels</b>	128	16
<b>Evaluation time</b>	15 ms	25 ms
<b>Evaluation elements</b>	Window, trapezoid, threshold, envelope, rotary switch, mathematical operations	Window, trapezoid, threshold, envelope
<b>X/Y-Reference (X-axis)</b>	Absolute, trigger, final force, reference line	Absolute, trigger, final force, reference line

## DigiControl PC SOFTWARE

The DigiControl PC software and DIGIFORCE® make a powerful team.

DIGIFORCE® works completely autonomously. It displays status information and evaluation results, and passes these to the controller. DigiControl is there to help you gain a closer understanding of the process and so increase process availability and reliability by offering numerous practical features, including convenient device configuration, data backups, automatic data logging mode (e.g. to capture production measurement data with clear parts references), a report viewer for analyzing test logs, and print-out and export of relevant quality data.

- Convenient device configuration via Ethernet or front-panel USB port
- Data backups (upload/download)
- Parallel administration of DIGIFORCE® 9307 and DIGIFORCE® 9311
- Online data acquisition and data export with component ID
- Synchronous logging of measurement data for multichannel applications
- Test report viewer for analyzing measurement logs
- Service functions such as device software update and remote control via the remote interface

The "Measurement mode" function displays the curve and status information of the most recent measurement, including in optional multichannel view. The associated measurement log is automatically saved in the background.

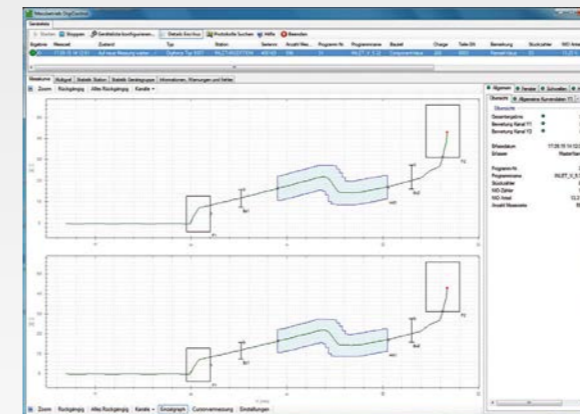

Clearly structured configuration windows enable convenient device setup. Settings can be changed step-by-step either at file level or directly with the DIGIFORCE®.

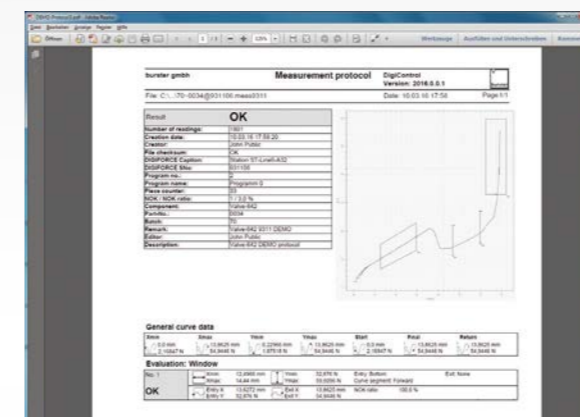
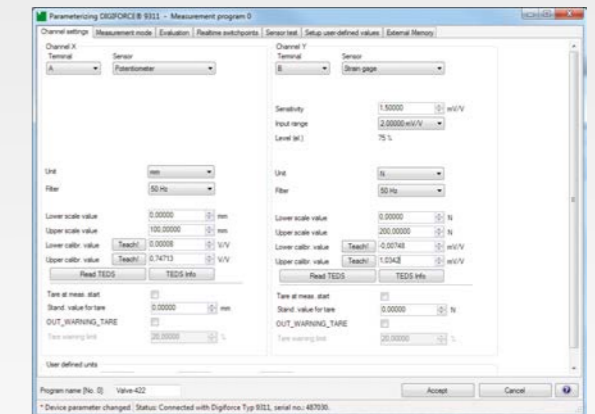

A Data-log wizard provides filters for selecting and displaying stored measurement logs. A report printout containing component data, curve information and all evaluation results can be generated for each individual measurement log.

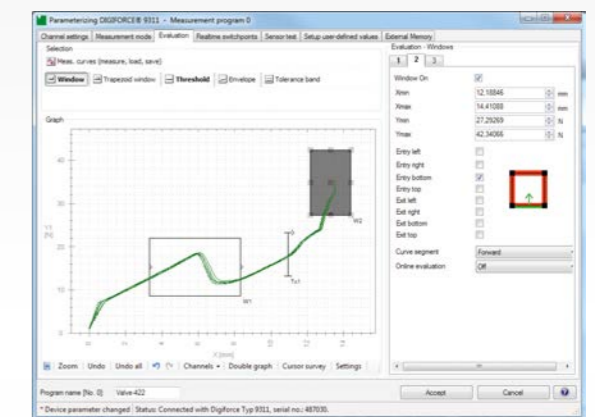

The window, trapezoid, threshold and envelope evaluation elements can be configured using the DigiControl PC software or directly from the touchscreen of DIGIFORCE® 9311.













# Your One-Stop Benefit

THE RIGHT SENSOR FOR YOUR JOB – FROM THE SENSOR EXPERTS.

**DIGIFORCE® 9307 and DIGIFORCE® 9311** provide built-in sensor interfaces that allow the simultaneous connection of one or more sensors. Manufacturer-independent the main measurement principles are supported: resistive with strain gauge, potentiometric, standard process signals, incremental TTL and analog, SSI and EnDat absolute encoder interface.

We recommend **burster sensors for outstanding measurement results and process reliability**. Please find hereafter a selection of sensors for major application fields:

<p><b>Miniature load cell</b> <b>8402</b></p>  <ul style="list-style-type: none"> <li>Measuring ranges from 0 ... 1 kN up to 0 ... 100 kN</li> <li>Ideal for dynamic compressive force measurements</li> <li>Standardized output signal</li> <li>Miniature dimensions</li> <li>Drug chain qualified cable</li> </ul>	<p><b>Precision miniature load cell</b> <b>8431</b></p>  <ul style="list-style-type: none"> <li>Measuring ranges from 0 ... 5 N up to 0 ... 100 kN</li> <li>For tensile and compressive forces</li> <li>High accuracy</li> <li>Small dimensions</li> <li>Minimum lateral sensitivity thanks to support diaphragms</li> <li>IP68 option</li> <li>Temperature compensation from -55 °C up to 200 °C</li> </ul>	<p><b>Tension and compression load cell</b> <b>8524</b></p>  <ul style="list-style-type: none"> <li>Measuring ranges from 0 ... 500 N up to 0 ... 200 kN</li> <li>For static and dynamic measurements of tensile and compressive forces</li> <li>Optional overload protection</li> <li>Extremely versatile</li> <li>Ultra-flexible drug chain qualified cable</li> </ul>	<p><b>Compression load cell</b> <b>8526</b></p>  <ul style="list-style-type: none"> <li>Measuring ranges from 0 ... 100 N up to 0 ... 200 kN</li> <li>For static and dynamic compressive force measurements</li> <li>Standardized sensitivity</li> <li>Compact design</li> <li>Welded IP64</li> <li>Particularly easy to fit</li> </ul>	<p><b>Presses load cell</b> <b>8451/8552</b></p>  <ul style="list-style-type: none"> <li>Measuring ranges from 0 ... 100 N up to 0 ... 100 kN</li> <li>Easy to mount on press ram</li> <li>Compact, highly robust and hermetically sealed design</li> <li>Suitable for all standard presses with a ram hole size of 8 H7 or 20 H7</li> </ul>
<p><b>Precision torque sensor</b> <b>8661</b></p>  <ul style="list-style-type: none"> <li>Measuring ranges from 0 ... ±0.02 Nm up to 0 ... ±1000 Nm</li> <li>Low linearity error <math>\leq \pm 0.05\%</math> F.S.</li> <li>Optional measurement of angle and speed</li> <li>Contactless</li> <li>Smart operating state indicator</li> <li>Ultra-compact</li> </ul>	<p><b>Potentiometric displacement sensors</b> <b>8709/8712/8718</b></p>  <ul style="list-style-type: none"> <li>Measuring ranges from 0 ... 10 mm up to 0 ... 2000 mm</li> <li>Non-linearity <math>\pm 0.05\%</math> F.S.</li> <li>Service life: <math>10^8</math> movements</li> <li>Positioning speed up to 10 m/s</li> <li>Available as stylus model or with free-moving rod</li> </ul>	<p><b>Incremental displacement transducer</b> <b>8738</b></p>  <ul style="list-style-type: none"> <li>Measuring ranges from 0 ... 5 mm up to 0 ... 100 mm</li> <li>Accuracy up to <math>\pm 0.5\ \mu\text{m}</math></li> <li>Diameter up to 8 mm</li> <li>Vibration-proof and dust-proof</li> <li>High degree of protection IP66</li> <li>Spring return</li> <li>Pneumatically operated models available</li> </ul>	<p><b>Inductive displacement transducer</b> <b>8739/8741</b></p>  <ul style="list-style-type: none"> <li>Measuring ranges from 0 ... 1 mm up to 0 ... 50 mm</li> <li>Non-linearity <math>\pm 0.25\%</math> F.S. or option to <math>\pm 0.1\%</math> F.S.</li> <li>Vibration-proof and shock-proof thanks to encapsulated electronics</li> <li>Ball-bearing mounted push-rod fitted with return spring and sensing tip</li> </ul>	<p><b>Inductive displacement sensor</b> <b>8740</b></p>  <ul style="list-style-type: none"> <li>Measuring ranges from 0 ... 1 mm up to 0 ... 150 mm</li> <li>Non-linearity <math>\pm 0.25\%</math> F.S. or option to <math>\pm 0.1\%</math> F.S.</li> <li>Push rod with 2 sliding Teflon rings and M2 thread for attaching to object under test</li> <li>2 m cable</li> </ul>

# Service

KEEPING THE BIG PICTURE IN MIND.



## GOOD ALL-ROUND ADVICE WITH DIGIFORCE®

burster provides a full range of services. Our "Carefree Service" strategy ensures that you can always **count on precise high-speed process monitoring with DIGIFORCE®**. Modular service components cover all aspects of your project.

### SYSTEM DESIGN



#### → KNOWLEDGEABLE APPLICATION SUPPORT

Our experts are happy to provide advice and help based on their experience gained over many years in production-process monitoring and quality assurance.

#### → OPTIMIZATION ADVICE

We make sure that you benefit from your measurement equipment while processes are running by continuously improving and optimizing your systems.

#### → USER TRAINING

In structured and efficient training units designed for commissioning engineers, service staff and production personnel, your staff learn how to integrate and use DIGIFORCE® controllers and sensors smoothly and effectively. In these training sessions we look specifically at your application.

### IMPLEMENTATION



#### → SYSTEM SETUP/COMMISSIONING

The clear operating structure of DIGIFORCE® lets you configure your system yourself. On-site startup support by one of our service engineers or service partners, which covers integration, fieldbus interfacing, parameter-setting, configuration and evaluation, can be provided for more complex system environments and customizations. We can also provide this support worldwide.

#### → CALIBRATION SERVICES

Our accredited calibration centre offers you optimum reliability and traceability for initial calibration and recalibration of your DIGIFORCE® controllers and accompanying sensors. We can quickly provide German-accredited DAkkS or factory calibration certificates by appointment. After consultation with us also on-site calibration can be considered where applicable to avoid production downtimes. Our experienced service engineers and service partners can provide support with detailed testing.

### OPERATION



#### → INTERNATIONAL ASSISTANCE & SUPPORT

DIGIFORCE® systems run in applications worldwide. So you are right to expect also worldwide service. In cooperation with our international partner network we support you on-site exactly where our products work for you.



THE MEASUREMENT SOLUTION.

burster

**BECAUSE PROGRESS  
NEEDS VISION.**

burster, the specialists for measuring equipment and sensors, delivers the ideal solution that meets your requirements to a T. We offer you forward-looking products, system solutions and a comprehensive suite of services to supplement our product range. With personal commitment and an uncompromising focus on quality.



Measuring technology with  
perspective.

THE MEASUREMENT SOLUTION.

burster

burster präzisionsmesstechnik  
gmbh & co kg  
Talstr. 1-5  
76593 Gernsbach, GERMANY